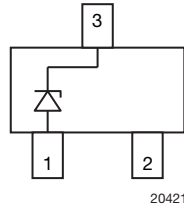

Small Signal Zener Diodes

RoHS
COMPLIANT

FEATURES

- These diodes are also available in other case styles and other configurations including: the SOD-123 case with type designation BZT52 series, the zener diode common anode configuration in the SOT-23 case with type designation AZ23 series and the zener diode common cathode configuration in the SOT-23 case with type designation DZ23 series
- The Zener voltages are graded according to the international E 24 standard. Standard zener voltage tolerance is $\pm 5\%$. Replace "C" with "B" for 2% tolerance.
- Silicon planar power Zener diodes
- AEC-Q101 qualified
- Compliant to RoHS Directive 2002/95/EC and in accordance to WEEE 2002/96/EC

PRIMARY CHARACTERISTICS

PARAMETER	VALUE	UNIT
V_Z range nom.	2.4 to 75	V
Test current I_{ZT}	2; 5	mA
V_Z specification	Pulse current	
Int. construction	Single	

ORDERING INFORMATION

DEVICE NAME	ORDERING CODE	TAPED UNITS PER REEL	MINIMUM ORDER QUANTITY
BZX84-V-series	BZX84-V-series-GS18	10 000 (8 mm tape on 13" reel)	10 000
BZX84-V-series	BZX84-V-series-GS08	3000 (8 mm tape on 7" reel)	15 000

PACKAGE

PACKAGE NAME	WEIGHT	MOLDING COMPOUND FLAMMABILITY RATING	MOISTURE SENSITIVITY LEVEL	SOLDERING CONDITIONS
SOT-23	8.8 mg	UL 94 V-0	MSL level 1 (according J-STD-020)	260 °C/10 s at terminals

ABSOLUTE MAXIMUM RATINGS

PARAMETER	TEST CONDITION	SYMBOL	VALUE	UNIT
Power dissipation	$T_{amb} = 25\text{ °C}$, device on fiberglass substrate, acc. layout on page 7	P_{tot}	300	mW
Thermal resistance junction to ambient air	$T_{amb} = 25\text{ °C}$, device on fiberglass substrate, acc. layout on page 7	R_{thJA}	420	K/W
Junction temperature		T_j	150	°C
Storage temperature range		T_{stg}	- 65 to + 150	°C



ELECTRICAL CHARACTERISTICS ($T_{amb} = 25\text{ }^{\circ}\text{C}$, unless otherwise specified)												
PART NUMBER	MARKING CODE	ZENER VOLTAGE RANGE			TEST CURRENT		REVERSE LEAKAGE CURRENT		DYNAMIC RESISTANCE $f = 1\text{ kHz}$		TEMPERATURE COEFFICIENT	
		V_Z at I_{ZT1}			I_{ZT1}	I_{ZT2}	I_R at V_R		Z_Z at I_{ZT1}	Z_{ZK} at I_{ZT2}	α_{VZ} at I_{ZT1}	
		V			mA		μA	V	Ω		$10^{-4}/^{\circ}\text{C}$	
		MIN.	NOM.	MAX.					MAX.	MAX.	MIN.	MAX.
BZX84C2V4-V	Z11	2.2	2.4	2.6	5	1	50	1	100	275	-9	-4
BZX84C2V7-V	Z12	2.5	2.7	2.9	5	1	20	1	100	600	-9	-4
BZX84C3V0-V	Z13	2.8	3.0	3.2	5	1	10	1	95	600	-9	-3
BZX84C3V3-V	Z14	3.1	3.3	3.5	5	1	5	1	95	600	-8	-3
BZX84C3V6-V	Z15	3.4	3.6	3.8	5	1	5	1	90	600	-8	-3
BZX84C3V9-V	Z16	3.7	3.9	4.1	5	1	3	1	90	600	-7	-3
BZX84C4V3-V	Z17	4.0	4.3	4.6	5	1	3	1	90	600	-6	-1
BZX84C4V7-V	Z1	4.4	4.7	5.0	5	1	3	2	80	500	-5	2
BZX84C5V1-V	Z2	4.8	5.1	5.4	5	1	2	2	60	480	-3	4
BZX84C5V6-V	Z3	5.2	5.6	6.0	5	1	1	2	40	400	-2	6
BZX84C6V2-V	Z4	5.8	6.2	6.6	5	1	3	4	10	150	-1	7
BZX84C6V8-V	Z5	6.4	6.8	7.2	5	1	2	4	15	80	2	7
BZX84C7V5-V	Z6	7.0	7.5	7.9	5	1	1	5	15	80	3	7
BZX84C8V2-V	Z7	7.7	8.2	8.7	5	1	0.7	5	15	80	4	7
BZX84C9V1-V	Z8	8.5	9.1	9.6	5	1	0.5	6	15	100	5	8
BZX84C10-V	Z9	9.4	10	10.6	5	1	0.2	7	20	150	5	8
BZX84C11-V	Y1	10.4	11	11.6	5	1	0.1	8	20	150	5	9
BZX84C12-V	Y2	11.4	12	12.7	5	1	0.1	8	25	150	6	9
BZX84C13-V	Y3	12.4	13	14.1	5	1	0.1	8	30	170	7	9
BZX84C15-V	Y4	13.8	15	15.6	5	1	0.05	10.5	30	200	7	9
BZX84C16-V	Y5	15.3	16	17.1	5	1	0.05	11.2	40	200	8	9.5
BZX84C18-V	Y6	16.8	18	19.1	5	1	0.05	12.6	45	225	8	9.5
BZX84C20-V	Y7	18.8	20	21.2	5	1	0.05	14.0	55	225	8	10
BZX84C22-V	Y8	20.8	22	23.3	5	1	0.05	15.4	55	250	8	10
BZX84C24-V	Y9	22.8	24	25.6	5	1	0.05	16.8	70	250	8	10
BZX84C27-V	Y10	25.1	27	28.9	2	0.5	0.05	18.9	80	300	8	10
BZX84C30-V	Y11	28	30	32	2	0.5	0.05	21.0	80	300	8	10
BZX84C33-V	Y12	31	33	35	2	0.5	0.05	23.1	80	325	8	10
BZX84C36-V	Y13	34	36	38	2	0.5	0.05	25.2	90	350	8	10
BZX84C39-V	Y14	37	39	41	2	0.5	0.05	27.3	130	350	10	12
BZX84C43-V	Y15	40	43	46	2	0.5	0.05	30.1	150	375	10	12
BZX84C47-V	Y16	44	47	50	2	0.5	0.05	32.9	170	375	10	12
BZX84C51-V	Y17	48	51	54	2	0.5	0.05	35.7	180	400	10	12
BZX84C56-V	Y18	52	56	60	2	0.5	0.05	39.2	200	425	9	11
BZX84C62-V	Y19	58	62	66	2	0.5	0.05	43.4	215	450	9	12
BZX84C68-V	Y20	64	68	72	2	0.5	0.05	47.6	240	475	10	12
BZX84C75-V	Y21	70	75	79	2	0.5	0.05	52.5	255	500	10	12



ELECTRICAL CHARACTERISTICS ($T_{amb} = 25\text{ }^{\circ}\text{C}$, unless otherwise specified)												
PART NUMBER	MARKING CODE	ZENER VOLTAGE RANGE			TEST CURRENT		REVERSE LEAKAGE CURRENT		DYNAMIC RESISTANCE $f = 1\text{ kHz}$		TEMPERATURE COEFFICIENT	
		V_Z at I_{ZT1}			I_{ZT1}	I_{ZT2}	I_R at V_R		Z_Z at I_{ZT1}	Z_{ZK} at I_{ZT2}	α_{VZ} at I_{ZT1}	
		V			mA		μA	V	Ω		$10^{-4}/^{\circ}\text{C}$	
		MIN.	NOM.	MAX.					MAX.	MAX.	MIN.	MAX.
BZX84B2V4-V	Z50	2.35	2.4	2.45	5	1	50	1	100	275	- 9	- 4
BZX84B2V7-V	Z51	2.65	2.7	2.75	5	1	20	1	100	600	- 9	- 4
BZX84B3V0-V	Z52	2.94	3.0	3.06	5	1	10	1	95	600	- 9	- 3
BZX84B3V3-V	Z53	3.23	3.3	3.37	5	1	5	1	95	600	- 8	- 3
BZX84B3V6-V	Z54	3.53	3.6	3.67	5	1	5	1	90	600	- 8	- 3
BZX84B3V9-V	Z55	3.82	3.9	3.98	5	1	3	1	90	600	- 7	- 3
BZX84B4V3-V	Z56	4.21	4.3	4.39	5	1	3	1	90	600	- 6	- 1
BZX84B4V7-V	Z57	4.61	4.7	4.79	5	1	3	2	80	500	- 5	2
BZX84B5V1-V	Z58	5.0	5.1	5.2	5	1	2	2	60	480	- 3	4
BZX84B5V6-V	Z59	5.49	5.6	5.71	5	1	1	2	40	400	- 2	6
BZX84B6V2-V	Z60	6.08	6.2	6.32	5	1	3	4	10	150	- 1	7
BZX84B6V8-V	Z61	6.66	6.8	6.94	5	1	2	4	15	80	2	7
BZX84B7V5-V	Z62	7.35	7.5	7.65	5	1	1	5	15	80	3	7
BZX84B8V2-V	Z63	8.04	8.2	8.36	5	1	0.7	5	15	80	4	7
BZX84B9V1-V	Z64	8.92	9.1	9.28	5	1	0.5	6	15	100	5	8
BZX84B10-V	Z65	9.8	10	10.2	5	1	0.2	7	20	150	5	8
BZX84B11-V	Z66	10.8	11	11.2	5	1	0.1	8	20	150	5	9
BZX84B12-V	Z67	11.8	12	12.2	5	1	0.1	8	25	150	6	9
BZX84B13-V	Z68	12.7	13	13.3	5	1	0.1	8	30	170	7	9
BZX84B15-V	Z69	14.7	15	15.3	5	1	0.05	10.5	30	200	7	9
BZX84B16-V	Z70	15.7	16	16.3	5	1	0.05	11.2	40	200	8	9.5
BZX84B18-V	Z71	17.6	18	18.4	5	1	0.05	12.6	45	225	8	9.5
BZX84B20-V	Z72	19.6	20	20.4	5	1	0.05	14	55	225	8	10
BZX84B22-V	Z73	21.6	22	22.4	5	1	0.05	15.4	55	250	8	10
BZX84B24-V	Z74	23.5	24	24.5	5	1	0.05	16.8	70	250	8	10
BZX84B27-V	Z75	26.5	27	27.5	2	0.5	0.05	18.9	80	300	8	10
BZX84B30-V	Z76	29.4	30	30.6	2	0.5	0.05	21	80	300	8	10
BZX84B33-V	Z77	32.3	33	33.7	2	0.5	0.05	23.1	80	325	8	10
BZX84B36-V	Z78	35.3	36	36.7	2	0.5	0.05	25.2	90	350	8	10
BZX84B39-V	Z79	38.2	39	39.8	2	0.5	0.05	27.3	130	350	10	12
BZX84B43-V	Z80	42.1	43	43.9	2	0.5	0.05	30.1	150	375	10	12
BZX84B47-V	Z81	46.1	47	47.9	2	0.5	0.05	32.9	170	375	10	12
BZX84B51-V	Z82	50	51	52	2	0.5	0.05	35.7	180	400	10	12
BZX84B56-V	Z83	54.9	56	57.1	2	0.5	0.05	39.2	200	425	9	11
BZX84B62-V	Z84	60.8	62	63.2	2	0.5	0.05	43.4	215	450	9	12
BZX84B68-V	Z85	66.6	68	69.4	2	0.5	0.05	47.6	240	475	10	12
BZX84B75-V	Z86	73.5	75	76.5	2	0.5	0.05	52.5	255	500	10	12

BASIC CHARACTERISTICS ($T_{amb} = 25\text{ }^{\circ}\text{C}$, unless otherwise specified)

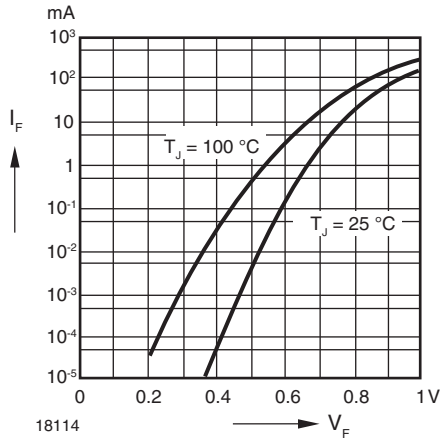

Fig. 1 - Forward Characteristics

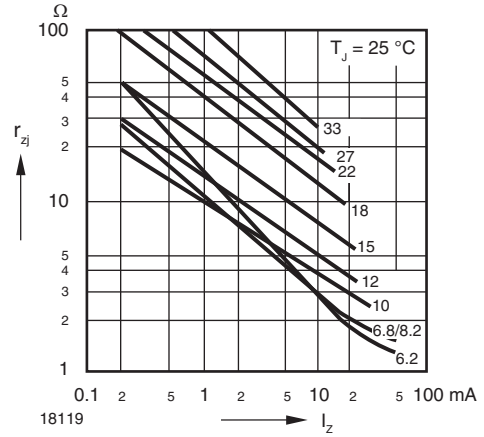

Fig. 4 - Dynamic Resistance vs. Zener Current

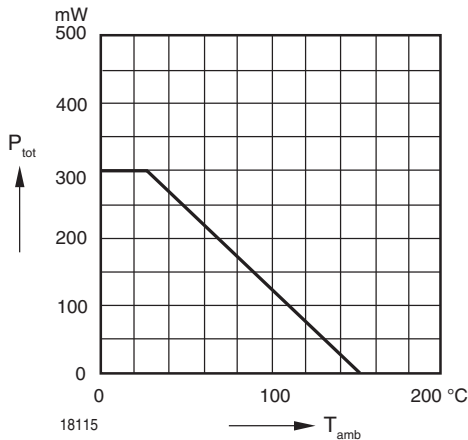

Fig. 2 - Admissible Power Dissipation vs. Ambient Temperature

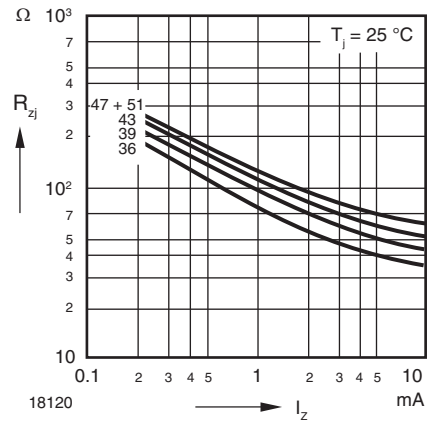

Fig. 5 - Dynamic Resistance vs. Zener Current

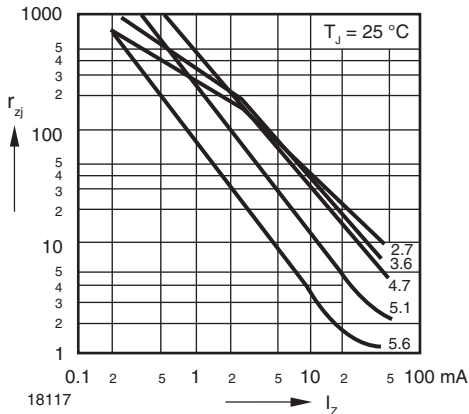

Fig. 3 - Dynamic Resistance vs. Zener Current

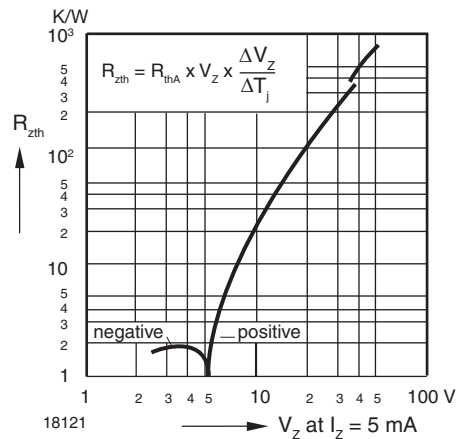

Fig. 6 - Thermal Differential Resistance vs. Zener Voltage

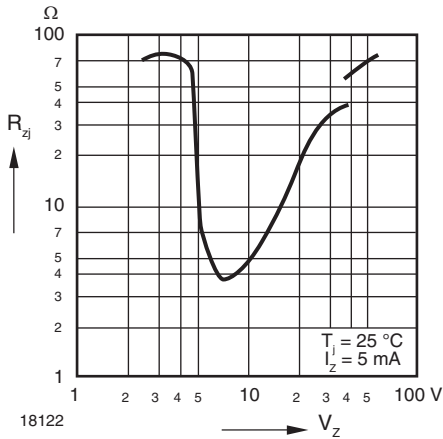

Fig. 7 - Dynamic Resistance vs. Zener Voltage

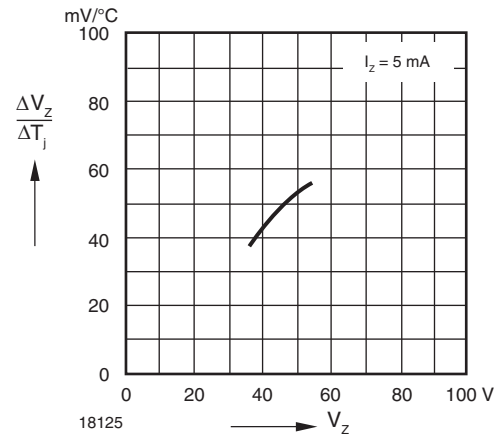

Fig. 10 - Temperature Dependence of Zener Voltage vs. Zener Voltage

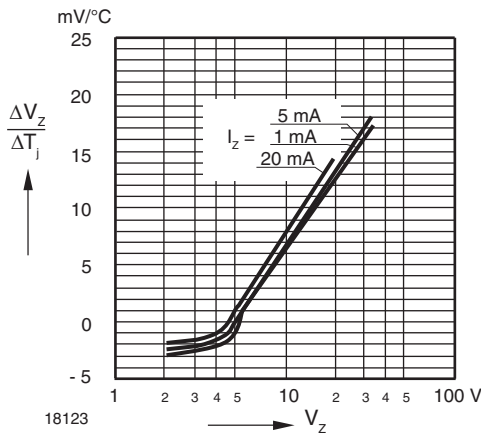

Fig. 8 - Temperature Dependence of Zener Voltage vs. Zener Voltage

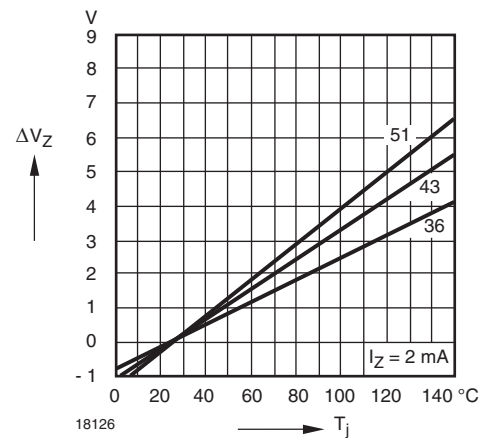

Fig. 11 - Change of Zener Voltage vs. Junction Temperature

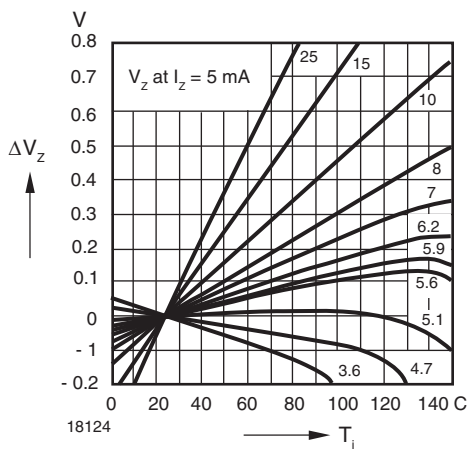

Fig. 9 - Change of Zener Voltage vs. Junction Temperature

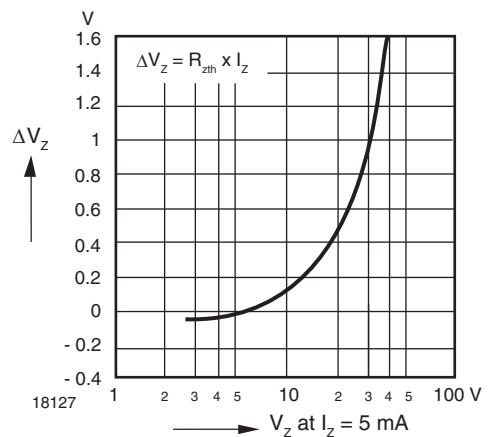

Fig. 12 - Change of Zener Voltage from Turn-on up to the Point of Thermal Equilibrium vs. Zener Voltage

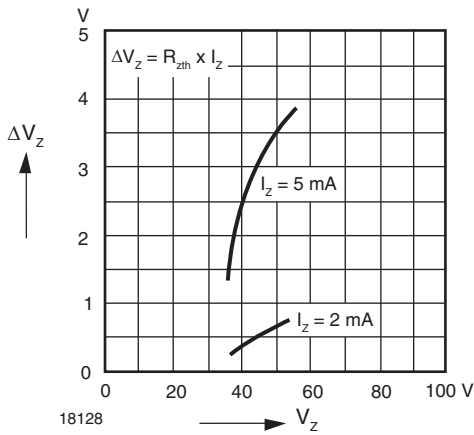

Fig. 13 - Change of Zener Voltage from Turn-on up to the Point of Thermal Equilibrium vs. Zener Voltage

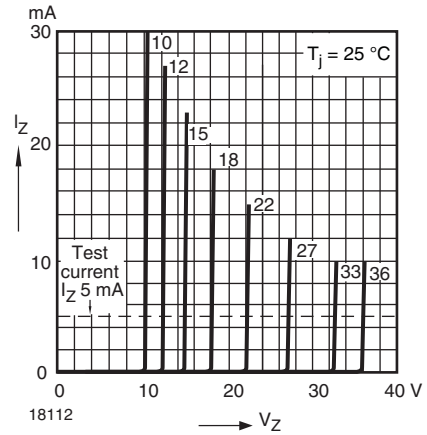

Fig. 15 - Breakdown Characteristics

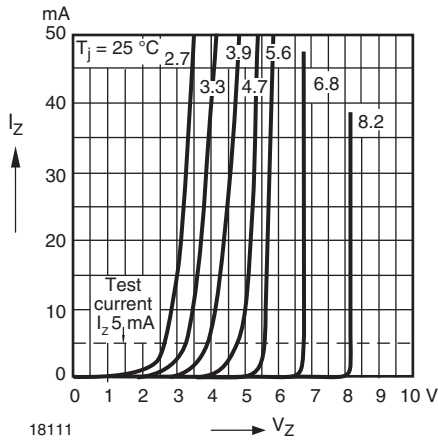

Fig. 14 - Breakdown Characteristics

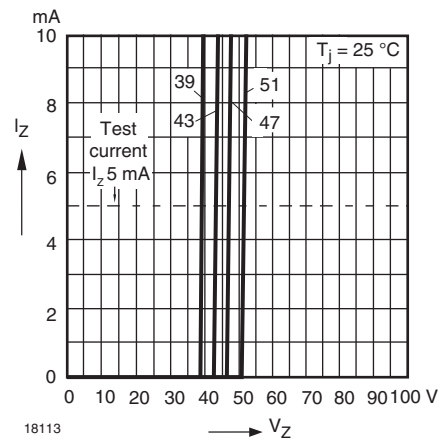

Fig. 16 - Breakdown Characteristics



LAYOUT FOR R_θ; J_A TEST

Thickness: fiberglass 0.059" (1.5 mm)

Copper leads 0.012" (0.3 mm)

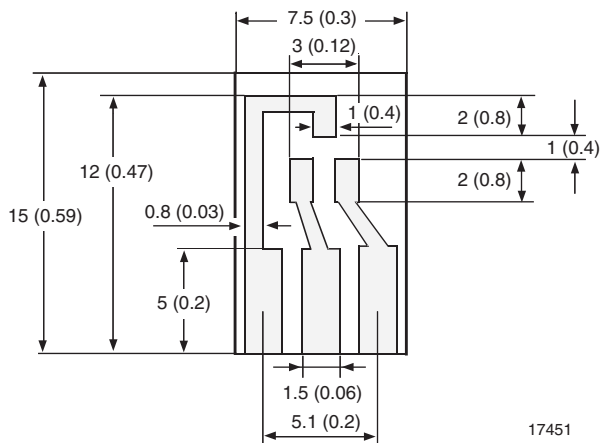

PACKAGE DIMENSIONS in millimeters (inches): SOT-23

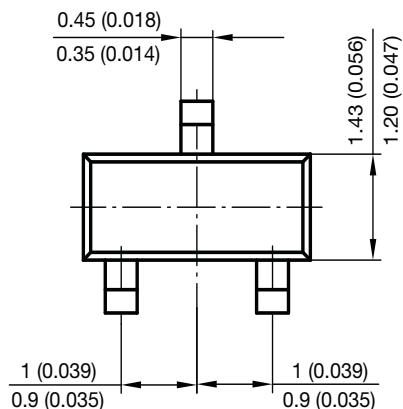
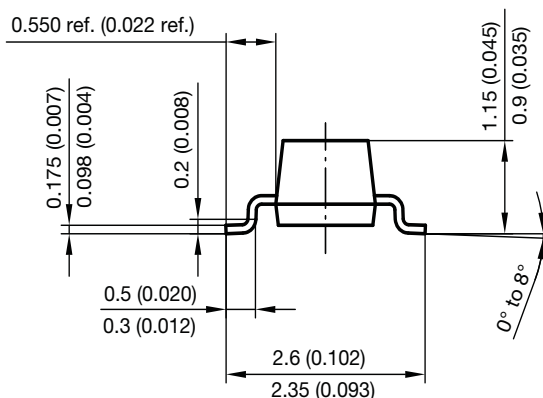
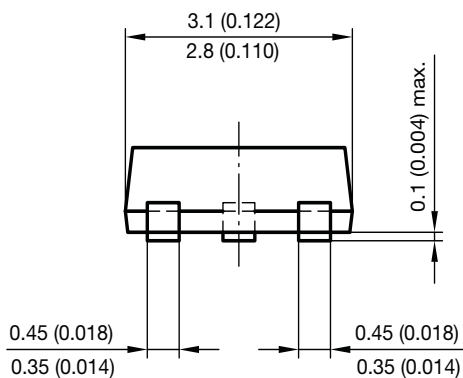

Foot print recommendation:

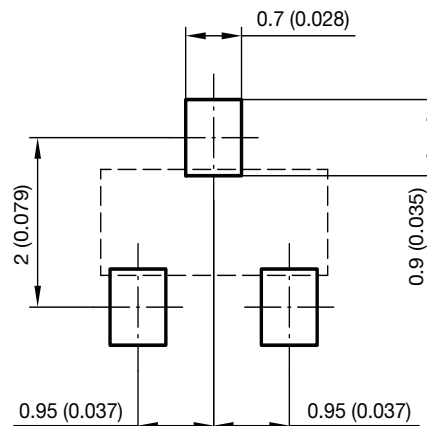



Disclaimer

ALL PRODUCT, PRODUCT SPECIFICATIONS AND DATA ARE SUBJECT TO CHANGE WITHOUT NOTICE TO IMPROVE RELIABILITY, FUNCTION OR DESIGN OR OTHERWISE.

Vishay Intertechnology, Inc., its affiliates, agents, and employees, and all persons acting on its or their behalf (collectively, "Vishay"), disclaim any and all liability for any errors, inaccuracies or incompleteness contained in any datasheet or in any other disclosure relating to any product.

Vishay makes no warranty, representation or guarantee regarding the suitability of the products for any particular purpose or the continuing production of any product. To the maximum extent permitted by applicable law, Vishay disclaims (i) any and all liability arising out of the application or use of any product, (ii) any and all liability, including without limitation special, consequential or incidental damages, and (iii) any and all implied warranties, including warranties of fitness for particular purpose, non-infringement and merchantability.

Statements regarding the suitability of products for certain types of applications are based on Vishay's knowledge of typical requirements that are often placed on Vishay products in generic applications. Such statements are not binding statements about the suitability of products for a particular application. It is the customer's responsibility to validate that a particular product with the properties described in the product specification is suitable for use in a particular application. Parameters provided in datasheets and/or specifications may vary in different applications and performance may vary over time. All operating parameters, including typical parameters, must be validated for each customer application by the customer's technical experts. Product specifications do not expand or otherwise modify Vishay's terms and conditions of purchase, including but not limited to the warranty expressed therein.

Except as expressly indicated in writing, Vishay products are not designed for use in medical, life-saving, or life-sustaining applications or for any other application in which the failure of the Vishay product could result in personal injury or death. Customers using or selling Vishay products not expressly indicated for use in such applications do so at their own risk and agree to fully indemnify and hold Vishay and its distributors harmless from and against any and all claims, liabilities, expenses and damages arising or resulting in connection with such use or sale, including attorneys fees, even if such claim alleges that Vishay or its distributor was negligent regarding the design or manufacture of the part. Please contact authorized Vishay personnel to obtain written terms and conditions regarding products designed for such applications.

No license, express or implied, by estoppel or otherwise, to any intellectual property rights is granted by this document or by any conduct of Vishay. Product names and markings noted herein may be trademarks of their respective owners.

Material Category Policy

Vishay Intertechnology, Inc. hereby certifies that all its products that are identified as RoHS-Compliant fulfill the definitions and restrictions defined under Directive 2011/65/EU of The European Parliament and of the Council of June 8, 2011 on the restriction of the use of certain hazardous substances in electrical and electronic equipment (EEE) - recast, unless otherwise specified as non-compliant.

Please note that some Vishay documentation may still make reference to RoHS Directive 2002/95/EC. We confirm that all the products identified as being compliant to Directive 2002/95/EC conform to Directive 2011/65/EU.